

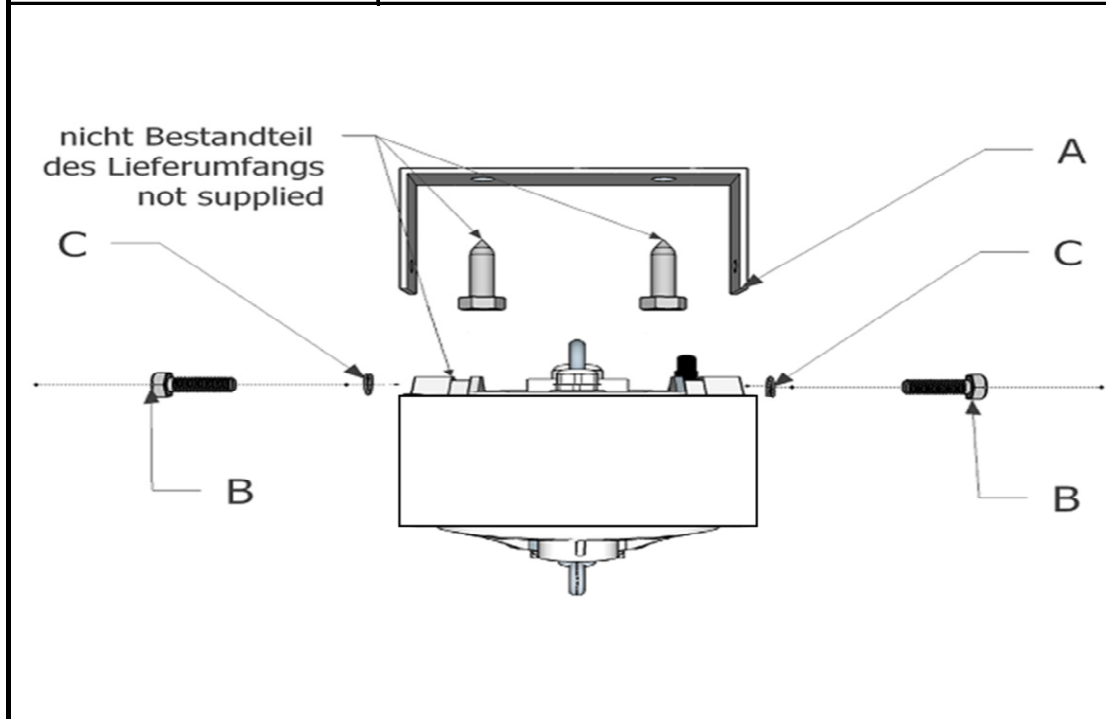

MB-M	Montageanleitung - Montagebügel für Mini Lifts Assembly instructions - Mounting Bracket for Mini lifts (MSI,MDI)
-------------	---

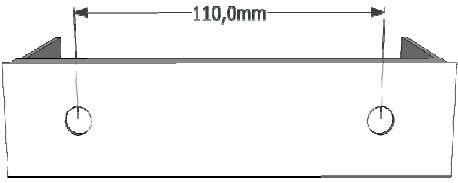

Component	Figure	Beschreibung / Description	Menge Amount
A		MB-M	1
B		Sechskantschraube / Hex bolt M8 x 14mm	2
C		Federring / snap ring M8	2

Benötigtes Werkzeug / needed tools			
Bohrmaschine Drill	Drehmomentschlüssel Torque Wrench	Drehmoment- schlüssel - Einsatz Socket	Wasserwaage Level
	25Nm	13	

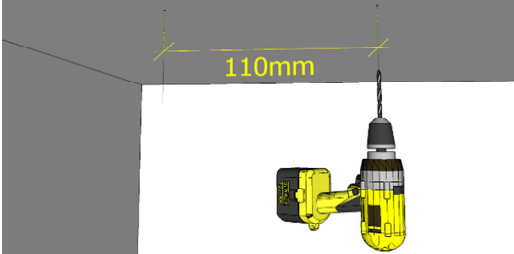
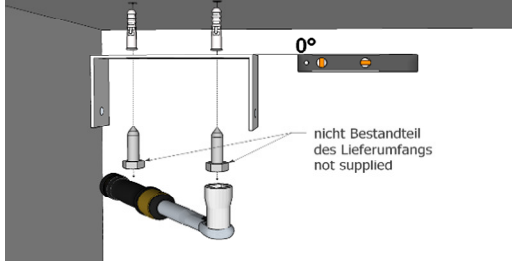
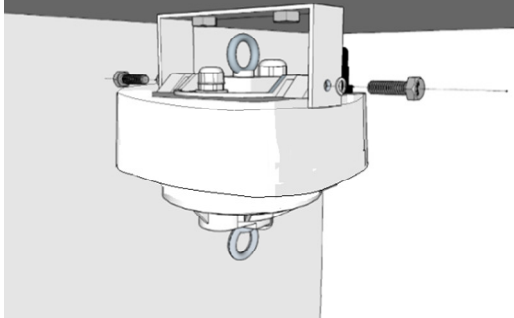
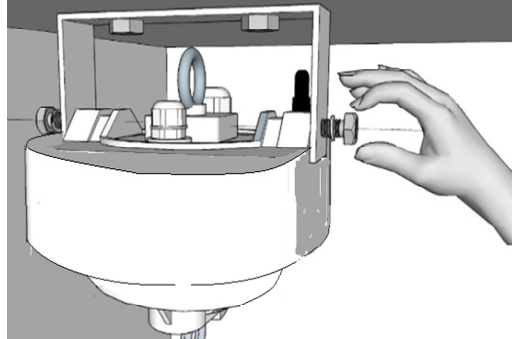
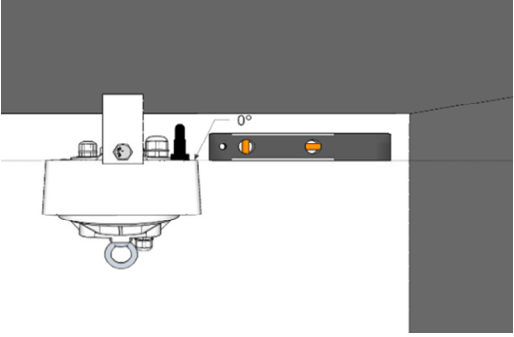
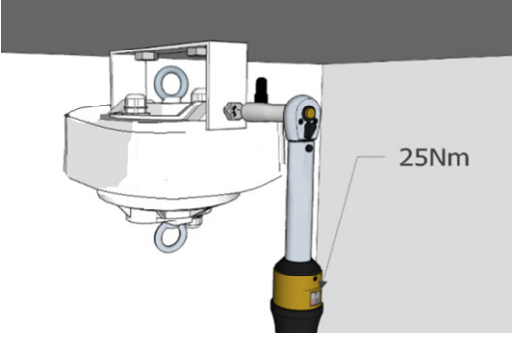
1		 <p>Befestigung nach statischen Erfordernissen entsprechend der lokalen Vorschriften unter Berücksichtigung der erforderlichen Sicherheitsbeiwerte</p> <p>Fit for static requirements according to local regulations under consideration of safety factors</p>	2
3			4
5			6
7			8
9	